

## Low Voltage Buck with Accurate Fsw and Fast Transient Response

### Features

- 2.5 to 5.5V Input Voltage Range
- Fixed Output Voltage = 1.3V
- 0.6 to 3.345V Programmable Option for Vout
  - ▶ 6.25mV steps below 1.39375V
  - ▶ 15mV steps above 1.44V
- 3.0A Output Current
- $\pm 1\%$  Accuracy at  $T_A = +25^\circ\text{C}$ 
  - ▶  $\pm 2.5\%$  over line/load/temp/setting
- Fast Transient Response
- Fast PLL Loop with accurate Switching frequency over load changes
- Dynamic Voltage Scaling (DVS) with 8 ramp rates
- 90% Peak Efficiency at  $V_{out} = 1.136\text{V}$
- 2.4MHz with Auto-Skip at light loads
  - ▶ Programmable forced-PWM mode
- 46 $\mu\text{A}$  typ. No-Load Supply Current in Skip Mode
- Tiny External Components
  - ▶  $L = 330$  or  $470\text{nH}$  (2012 or 2016 metric size)
  - ▶  $C_{in} = 10\mu\text{F}$  (0402),  $C_{out} = 2 \times 22\mu\text{F}$  (2x0402)
- Soft Start, Over-Current, Short-Circuit, Under/Over- $V_{in}$ , and Thermal Shutdown Protections
- 1MHz I<sup>2</sup>C Interface
- $-40^\circ\text{C}$  to  $85^\circ\text{C}$  Operating Temperature Range
- 15-bump Pb-free WLCSP (0.4mm pitch)
  - ▶  $1.340 \times 2.045\text{mm}$  (0.6mm height)
  - ▶ Pin/Register Compatible with FAN53527

### Brief Description

The KTB8400 is a precision and unique OptiComp™ buck switching regulator with class-leading accuracy, transient response, efficiency, and solution size optimized for mobile and non-mobile application. It is I<sup>2</sup>C programmable for output voltages in the 0.6V to 3.345V range. It features soft-start and DVS with multiple programmable ramp rates. Versions with various default settings can be ordered. The features and performance make the KTB8400 suitable for a variety of applications including CPU/GPU core, DSP and baseband, DDR memory, VIO, and sensor/analog power.

The KTB8400 is available in RoHS and Green compliant 15-bump 1.340mm x 2.045mm x 0.6mm wafer-level chip-scale package (WLCSP).

### Applications

- CPU, GPU, AP, DSP, FPGA, I/O, XCVR Power
- HDD, LPDDR3, LPDDR4, LPDDR5 Memory Power
- Tablets, Netbooks, Ultra-Books
- Smartphones, Mobile Internet Devices, IoT
- DSC, Drones, Gaming Consoles, Accessories

### Typical Application Schematic

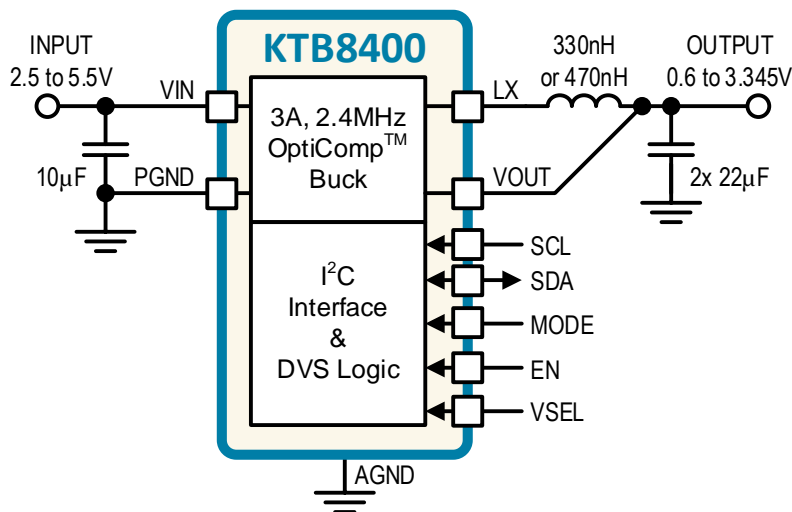

## Pin Descriptions

Pin #	Name	Function
A1, B1, C1	VIN	Voltage Input for buck regulator and IC power
A3, B3	PGND	Power Ground for buck regulator
C3, E1	AGND	Analog Ground for IC power
A2, B2	LX	Inductor Connection for buck regulator
E3	VOUT	Output Voltage sense input
D2	EN	Chip Enable logic input
E2	SCL	I <sup>2</sup> C Clock digital input
D3	SDA	I <sup>2</sup> C Data digital I/O
C2	MODE	Operation mode select MODE = 0 (LOW): The IC follows register bits MODE0 and MODE1 for Auto-Skip or Forced-PWM operation MODE = 1 (HIGH): The IC enters Forced-PWM mode regardless of register bit MODE0 and MODE1 status. Do not let this pin float.
D1	VSEL	DVS Voltage Select and Auto-Skip vs. Forced-PWM Mode Select logic input

## Pinout Diagram

### WLCSP-15

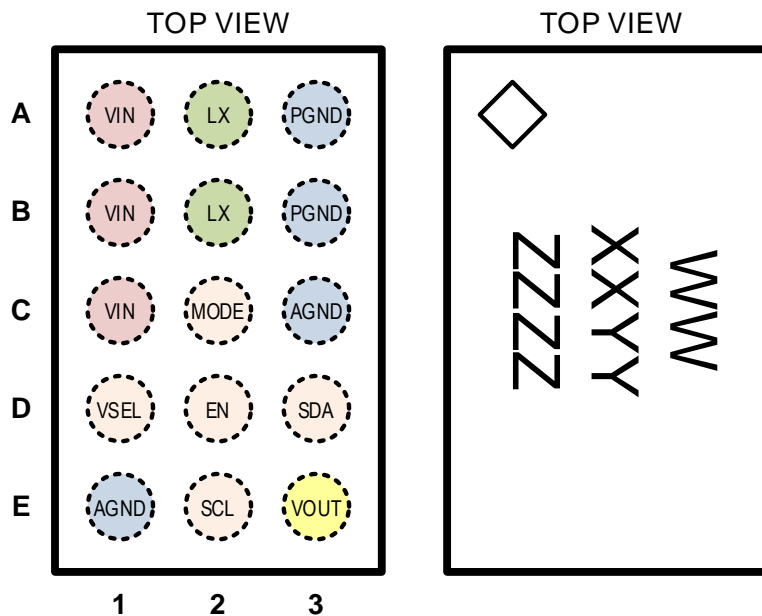

15-Bump 1.340mm x 2.045mm x 0.62mm  
WLCSP Package, 0.4mm pitch

#### Top Mark

WW = Device Code,  
XX = Date Code, YY = Assembly Code,  
ZZZZ = Serial Number

## Absolute Maximum Ratings<sup>1</sup>

(T<sub>A</sub> = 25°C unless otherwise noted)

Symbol	Description	Value	Units
V <sub>IN</sub>	VIN to AGND	-0.3 to 6	V
V <sub>PGND</sub>	PGND to AGND	-0.3 to 0.3	V
V <sub>LX<sup>2</sup></sub>	LX to PGND	-0.3 to (V <sub>IN</sub> +0.3)	V
V <sub>OUT</sub>	VOUT to AGND	-0.3 to (V <sub>IN</sub> +0.3)	V
V <sub>IO</sub>	SCL, SDA, VSEL to AGND	-0.3 to 6	V
	EN, MODE to AGND	-0.3 to V <sub>IN</sub>	V
I <sub>LX</sub>	LX Continuous Current	3.2	A <sub>RMS</sub>
	LX Peak Current (1ms maximum)	9.6	A <sub>PEAK</sub>
T <sub>J</sub>	Operating Junction Temperature Range	-40 to 150	°C
T <sub>S</sub>	Storage Temperature Range	-55 to 150	°C
T <sub>LEAD</sub>	Maximum Soldering Temperature (at leads, 10 sec)	260	°C

## ESD Ratings<sup>3</sup>

Symbol	Description	Value	Units
V <sub>ESD_HBM</sub>	JEDEC JS-001-2017 ESD Human Body Model (all pins)	±2	kV

## Thermal Capabilities<sup>4</sup>

Symbol	Description	Value	Units
Θ <sub>JA</sub>	Thermal Resistance – Junction to Ambient	77	°C/W
P <sub>D</sub>	Maximum Power Dissipation at T <sub>A</sub> = 25°C	1.62	W
ΔP <sub>D</sub> /ΔT	Derating Factor Above T <sub>A</sub> = 25°C	-13	mW/°C

## Ordering Information

Part Number	Marking <sup>5</sup>	Default Output Voltage & Mode <sup>6</sup>		7-bit I <sup>2</sup> C Slave Address	Package
		(VSEL = 1)	(VSEL = 0)		
KTB8400AEDAA-TR	TRXXYYZZZZ	1.3V Forced-PWM	1.3V Auto-Skip	1100 000=0x60h	WLCSP15

- Stresses above those listed in Absolute Maximum Ratings may cause permanent damage to the device. Functional operation at conditions other than the operating conditions specified is not implied. Only one Absolute Maximum rating should be applied at any one time.
- Absolute Maximum Rating for VLX is a DC voltage rating. During normal switching operation, short-duration voltage spikes beyond the DC rating are expected and normal for all DC-DC switching regulators.
- ESD Ratings conform to JEDEC industry standards. Some pins may actually have higher performance.
- Junction to Ambient thermal resistance is highly dependent on PCB layout. Values are based on thermal properties of the device when soldered to an EV board.
- “WW” is the device ID, “XX” is the date code, “YY” is the assembly code, and “ZZZZ” is the serial number.
- Contact a Kinetic Technologies representative regarding versions with other default settings.

## Electrical Characteristics<sup>7</sup>

Unless otherwise noted, the *Min* and *Max* specs are applied over the full operation temperature range of -40°C to +85°C and  $V_{IN} = 2.5V$  to  $5.5V$ . *Typ* values are specified at +25°C with  $V_{IN} = 3.6V$ .

### Supply Specifications

Symbol	Description	Conditions	Min	Typ	Max	Units
$V_{IN}$	Input Supply Operating Range		2.5		5.5	V
$V_{UVLO}$	Under-Voltage Lockout Threshold	$V_{IN}$ rising $V_{IN}$ hysteresis	2.15	2.3 200	2.49	V mV
$V_{OVP}$	Over-Voltage Protection Threshold	$V_{IN}$ rising	5.55	5.75	5.95	V
		$V_{IN}$ hysteresis		200		mV
$I_{IN}$	No-Load Supply Current	$EN = 1, V_{IN} = 3.6V, V_{OUT} \leq 2.5V, \text{Skip}$		46	80	$\mu A$
		$EN = 1, V_{IN} = 3.6V, \text{Forced-PWM}$		20		mA
$I_{SHDN}$	Shutdown Supply Current	$EN = 0, T_A = 25^\circ C$		0.2	1	$\mu A$
		$EN = 1, ENn[0]=0, T_A = 25^\circ C$		0.2	1.5	$\mu A$

### Logic Pin Specifications

Symbol	Description	Conditions	Min	Typ	Max	Units
MODE						
$V_{IH}$	Input Logic High		$0.6V_{IN}$			V
$V_{IL}$	Input Logic Low				$0.3V_{IN}$	V
EN, VSEL						
$V_{IH}$	Input Logic High		1.15			V
$V_{IL}$	Input Logic Low				0.4	V
$I_{LK}$	Input Logic Leakage	$T_A = 25^\circ C, V_I = 0V \text{ or } V_{IN}$	-1	$\pm 0.01$	1	$\mu A$
$R_{I\_PD}$	Input Logic Pull-Down (EN, VSEL)	only connected when $V_I \leq V_{IL}$ (disconnected when $V_I \geq V_{IH}$ )		250		k $\Omega$

### Thermal Shutdown Specifications

Symbol	Description	Conditions	Min	Typ	Max	Units
$T_{J\_SHDN}$	IC Junction Thermal Shutdown <sup>8</sup>	$T_J$ rising		150		$^\circ C$
		Hysteresis		20		$^\circ C$

(continued next page)

7. Device is guaranteed to meet performance specifications over the -40°C to +85°C operating temperature range by design, characterization and correlation with statistical process controls.

8. Guaranteed by design, characterization and statistical process control methods; not production tested.

## Electrical Characteristics (continued)<sup>7</sup>

Unless otherwise noted, the *Min* and *Max* specs are applied over the full operation temperature range of -40°C to +85°C and  $V_{IN} = 2.5V$  to  $5.5V$ . *Typ* values are specified at +25°C with  $V_{IN} = 3.6V$ .

### I<sup>2</sup>C-Compatible Interface Specifications (SCL, SDA), see Figure 1

Symbol	Description	Conditions	Min	Typ	Max	Units
$V_{IH}$	Input Logic High Threshold		1.1			V
$V_{IL}$	Input Logic Low Threshold				0.4	V
$V_{OL}$	SDA Output Logic Low	$I_{SDA} = 3mA$			0.4	V
$t_1$	SCL clock period <sup>8</sup>		2.5			$\mu s$
$t_2$	Data in setup time to SCL high <sup>8</sup>		100			ns
$t_3$	Data out stable after SCL low <sup>8</sup>		0			ns
$t_4$	SDA low setup time to SCL low (Start) <sup>8</sup>		100			ns
$t_5$	SDA high hold time after SCL high (Stop) <sup>8</sup>		100			ns

(continued next page)

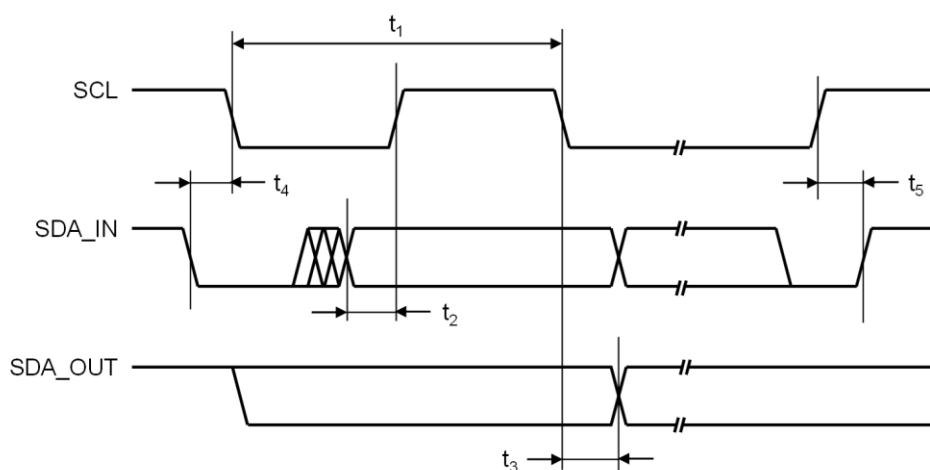

Figure 1. I<sup>2</sup>C Compatible Interface Timing

**Electrical Characteristics (continued)<sup>7</sup>**

Unless otherwise noted, the *Min* and *Max* specs are applied over the full operation temperature range of -40°C to +85°C and  $V_{IN} = 2.5V$  to  $5.5V$ . *Typ* values are specified at +25°C with  $V_{IN} = 3.6V$ .

**Buck Regulator Specifications**

Symbol	Description	Conditions	Min	Typ	Max	Units
$V_{OUT}$	Output Voltage Setting Range	Low Range (G=1), RANGE[0]=0	0.600		1.39375	V
		High Range (G=2.4), RANGE[0]=1	1.440		3.345	V
$V_{OUT\_STEP}$	Output Voltage Setting Step Size	Low Range (G=1), RANGE[0]=0		6.25		mV
		High Range (G=2.4), RANGE[0]=1		15		mV
$V_{OUT\_ACC}$	Output Voltage DC Accuracy	$T_A = 25^\circ C$ , $V_{OUT} = 1.136V$ , FPWM	-1	$\pm 0.2$	1	%
		FPWM over line/load/temp/setting	-2.5	$\pm 1$	2.5	%
		Auto-Skip over line/setting		$\pm 1$		%
$V_{OUT\_LOAD}$	Output Voltage Load Regulation <sup>8</sup>	$I_{LOAD} = 1A$ to $3A$ , FPWM		-0.01		%/A
$V_{OUT\_LINE}$	Output Voltage Line Regulation <sup>8</sup>	$V_{IN} = 2.5V$ to $5.5V$ , $I_{LOAD} = 1.5A$		$\pm 0.01$		%/V
$V_{OUT\_TRAN}$	Output Voltage Transient Response <sup>8</sup>	$I_{LOAD} = 10mA \leftrightarrow 1.5A$ , $t_r = t_f = 200ns$ , $V_{OUT} = 1.136V$		$\pm 50$		mV
$I_{OUT\_MAX}$	Maximum Output Current		3			A
$I_{LX\_PEAK}$	LX Peak Current Limit		4	4.6	5.5	A
$I_{LX\_VALLEY}$	LX Valley Current Limit		3	4.3	5.5	A
$I_{LX\_LEAK}$	LX Leakage Current	$V_{LX} = 0V$ or $5.5V$ , $T_A = 25^\circ C$		0.1	1	$\mu A$
$R_{DSON\_MS}$	Main Switch On-Resistance	MOSFET + metal + bumps		50		m $\Omega$
$R_{DSON\_SR}$	Synch. Rectifier On-Resistance	MOSFET + metal + bumps		30		m $\Omega$
$R_{LX\_DIS}$	LX Active Discharge Resistance	EN = 0 or ENn[0] = 0, DIS[0] = 1		133		$\Omega$
$t_{SS\_DELAY}$	Soft-Start Ramp Delay <sup>8</sup>	Hardware enable, EN=0→1		170		$\mu s$
		Software enable, ENn[0] = 0→1				
$dV/dt_{SS}$	Soft-Start Ramp Rates	$V_{IN} = 3.6V$ , RANGE[0]=0		18		mV/ $\mu s$
		$V_{IN} = 3.6V$ , RANGE[0]=1		38		
$t_{DVS\_DELAY}$	DVS Ramp Delay <sup>8</sup>	Hardware DVS, VSEL = 0↔1		5		$\mu s$
		Software DVS, by I <sup>2</sup> C command		<10		$\mu s$
$dV/dt_{DVS}$	DVS Ramp Rates	8 programmable rates	3.125		25	mV/ $\mu s$
$V_{OUT\_POK}$	$V_{OUT}$ Power OK Threshold	Percentage of $V_{OUT}$ setting, falling		88		%
		Percentage of $V_{OUT}$ setting, rising		92		%

## Typical Characteristics

Unless otherwise noted,  $V_{IN} = V_{EN} = 3.6V$ ,  $L = 330nH$ ,  $C_{IN} = 10\mu F$ ,  $C_{OUT} = 2x 22\mu F$ , and  $T_A = 25^\circ C$ .

**Efficiency vs. Load at  $V_{OUT} = 1.136V$**

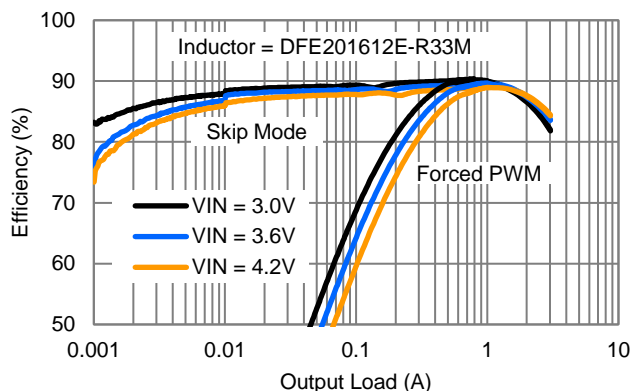

**$V_{OUT}$  Setting Accuracy ( $I_{OUT} = 10mA$ )**

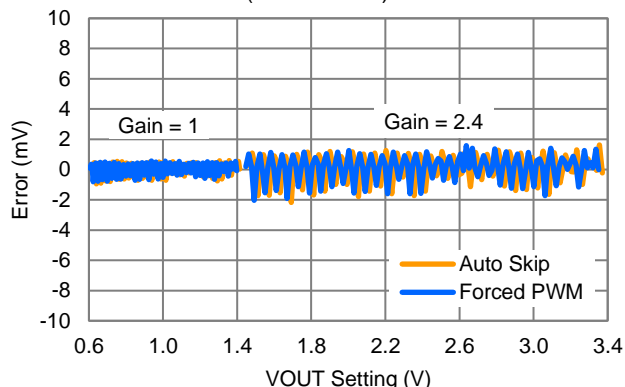

**$V_{OUT}$  Accuracy vs. Load (FPWM) ( $V_{OUT} = 1.136V$ )**

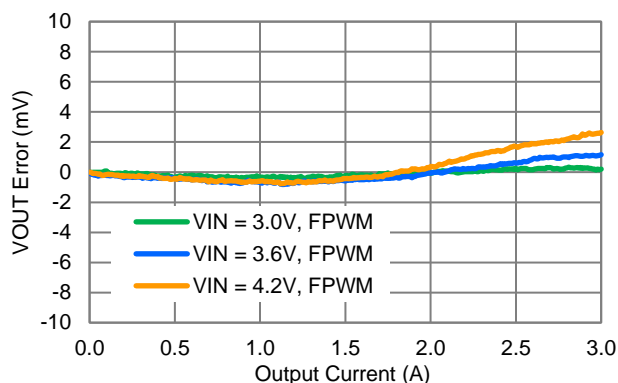

**Supply Current vs.  $V_{IN}$  ( $V_{OUT} = 1.136V$ , No Load, Mode = Auto)**

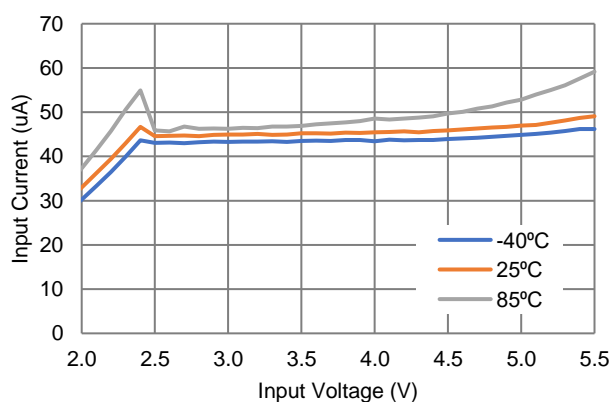

**Shutdown Supply Current vs.  $V_{IN}$**

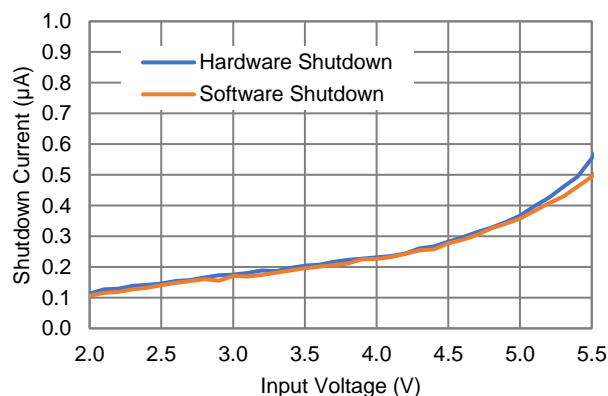

**$V_{LX}$  and  $I_{LX}$  Switching Waveforms ( $V_{OUT} = 1.136V$ , Mode = Auto)**

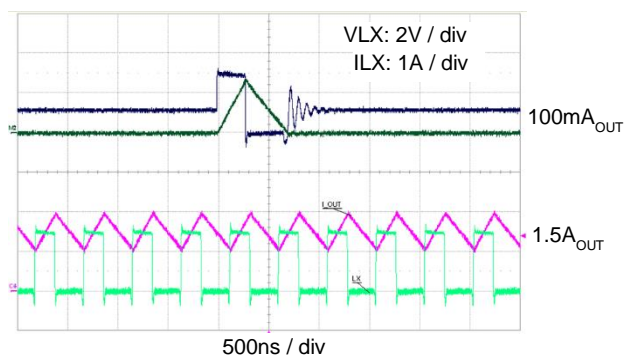

## Typical Characteristics (continued)

Unless otherwise noted,  $V_{IN} = V_{EN} = 3.6V$ ,  $L = 330nH$ ,  $C_{IN} = 10\mu F$ ,  $C_{OUT} = 2 \times 22\mu F$ , and  $T_A = 25^\circ C$ .

**V<sub>OUT</sub> Ripple Waveforms**  
(V<sub>OUT</sub> = 1.136V, Mode = Auto)

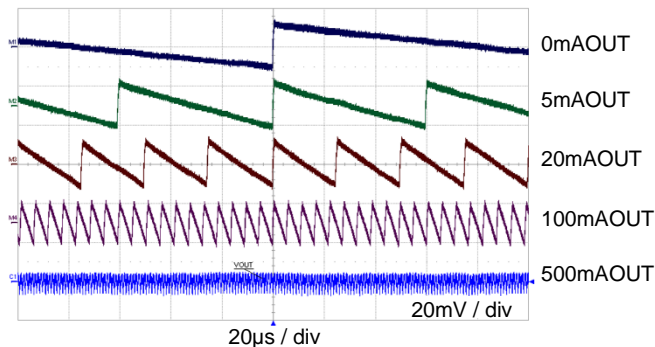

**Short-Circuit Protection**

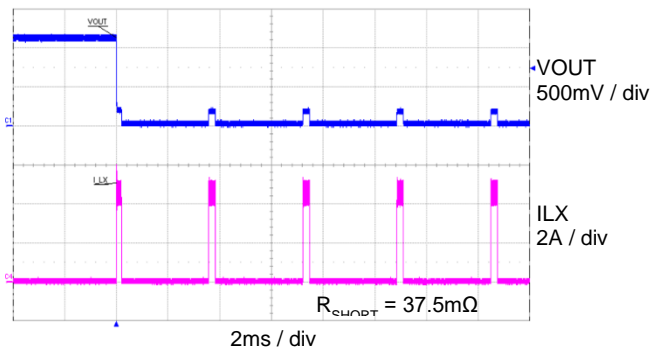

**Load Transient Response**  
(V<sub>OUT</sub> = 1.136V, Load = 10mA-1.5A, Mode = FPWM)

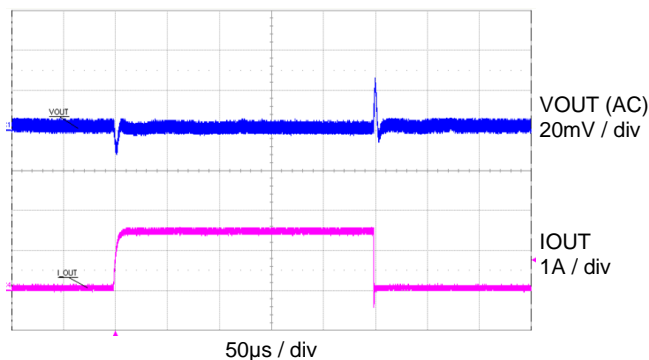

**Load Transient Response**  
(V<sub>OUT</sub> = 1.136V, Load = 1.5A-3A, Mode = Auto)

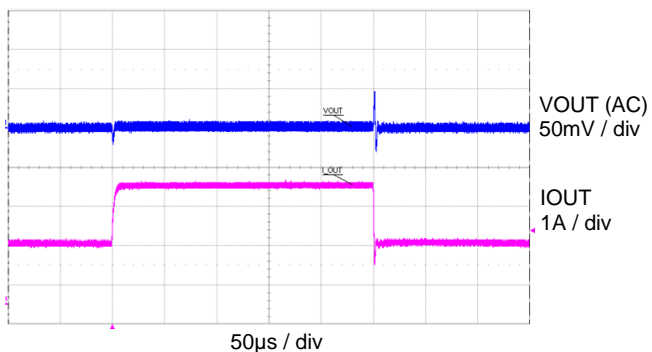

**Line Transient Response**  
(V<sub>OUT</sub> = 1.136V, Mode = Auto)

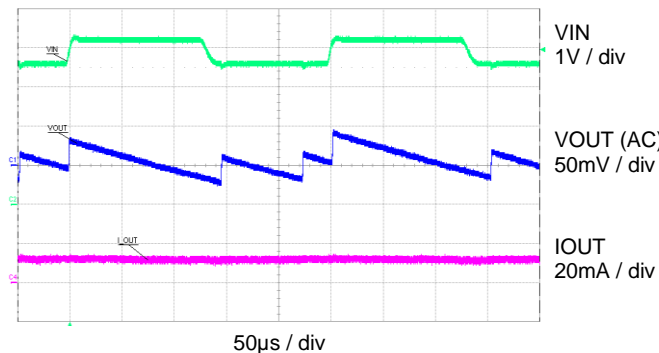

**Line Transient Response**  
(V<sub>OUT</sub> = 1.136V, Mode = FPWM)

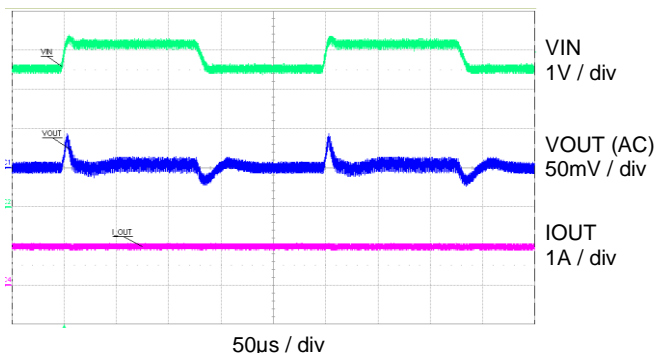



## Typical Characteristics (continued)

Unless otherwise noted,  $V_{IN} = V_{EN} = 3.6V$ ,  $L = 330nH$ ,  $C_{IN} = 10\mu F$ ,  $C_{OUT} = 2x 22\mu F$ , and  $T_A = 25^\circ C$ .

**Buck Enable Soft-Start Rates**  
( $V_{OUT} = 1.136V$ )

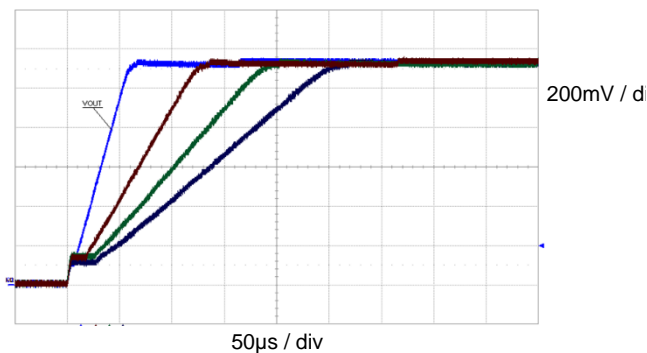

**DVS Positive Ramp-Up Rates**  
( $V_{OUT} = 0.9-1.2V$ )

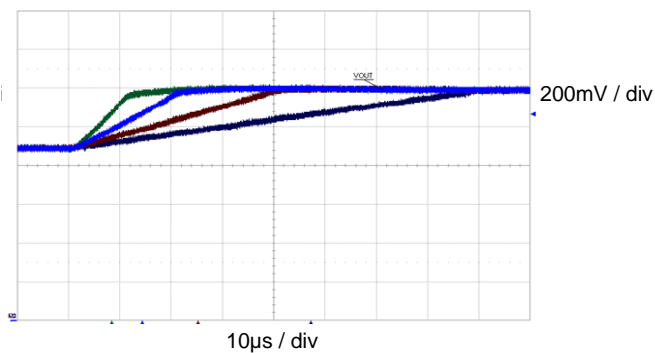

**DVS Negative Ramp-Down Rates**  
( $V_{OUT} = 1.2-0.9V$ )

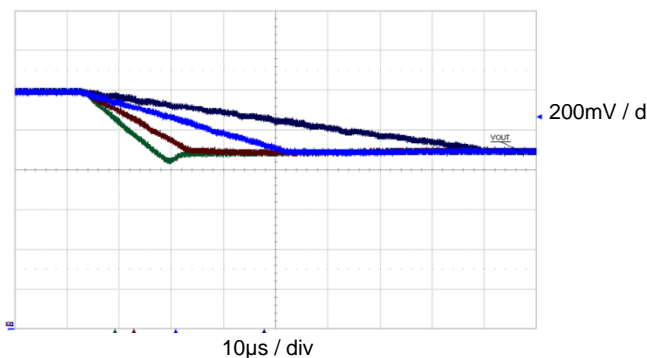

**Buck Shutdown**  
( $V_{OUT} = 1.136V$ , Active Discharge Enabled)

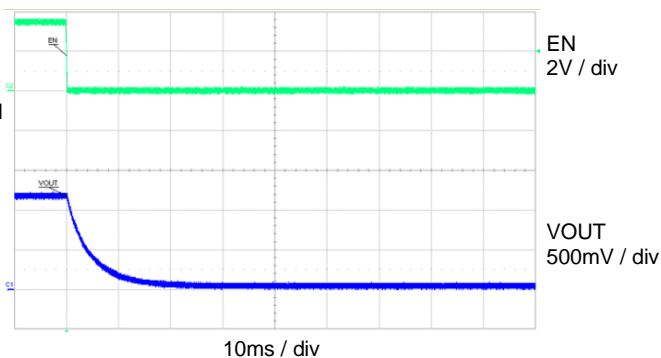

**Buck Shutdown**  
( $V_{OUT} = 1.136V$ , Active Discharge Disabled)

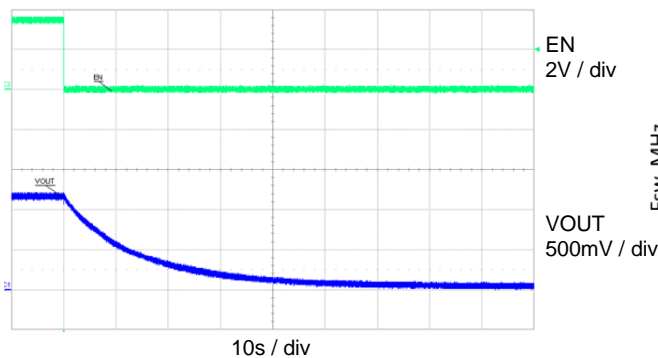

**Switching Frequency Accuracy vs Iout**  
( $V_{OUT} = 1.136V$ )

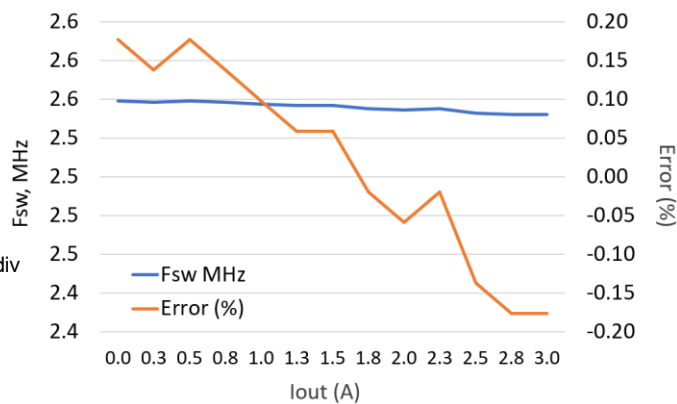

## Functional Description

The KTB8400 is a highly efficient, high-performance, small buck regulator that operates from an input voltage of 2.5V to 5.5V and can output up to 3A. It integrates the main switch, synchronous rectifier switch, PWM control circuitry,  $V_{OUT}$  setting DAC, various protection features, and an I<sup>2</sup>C serial interface to configure the output voltage, dynamic voltage scaling (DVS), control modes, and interrupts.

### Control Scheme

The KTB8400 uses a proprietary adaptive on-time OptiComp™ PWM control scheme to maintain a nearly constant switching frequency as input voltage and output voltage vary. Compared to typical current-mode PWM schemes, the OptiComp™ control scheme provides quick response to line and load transients with excellent stability and wide bandwidth, thereby minimizing output voltage droop and soar for dynamic loads, even with minimal output capacitance. The adaptive on-time approximates fixed-frequency switching without using a fixed clock oscillator, which eliminates the need to wait for the next clock before responding to a load transient.

The KTB8400 feedback loop also adds a proprietary, internally-compensated, integrating error amplifier to remove the output voltage offset normally associated with other OptiComp™, constant on-time (COT), and hysteretic architectures.

### Shutdown Mode

When the EN pin is low, the KTB8400 buck is in shutdown mode and draws very little current. In shutdown, the I<sup>2</sup>C is still active, allowing read and write commands, as long as  $V_{IN}$  is above  $V_{UVLO}$ . Similarly, register contents are retained during shutdown (and even when  $V_{IN}$  is a little below  $V_{UVLO}$ ), as long as  $V_{IN}$  is above  $V_{POR}=1.8V$ .

### Hardware Enable

The KTB8400 buck regulator is turned on and off via hardware enable using the EN pin or via software enable using I<sup>2</sup>C commands. The default register settings allow simple hardware control. For hardware enable, drive the EN pin high. For hardware disable, drive the EN pin low.

### Software Enable

For software enable/disable control, first write 0 into the EN0 bit (B7) of the VSEL0 configuration register (0x00), and/or write 0 into the EN1 bit (B7) of the VSEL1 configuration register (0x01). The VSEL pin determines which register is used. Then bring the EN pin high. After that, write 1 into the corresponding EN0 or EN1 bit to enable the buck, and write 0 to disable the buck.

### Soft-Start

The KTB8400 buck contains soft-start circuitry to ramp up  $V_{OUT}$  slowly in order to reduce inrush current at  $V_{IN}$  and prevent the inductor current from reaching the peak current limit ( $I_{LX\_PEAK}$ ) during startup. The inductor's average current during soft-start is given by:

$$I_{L\_SS} = C_{OUT} \times (dV/dt_{SS}) + I_{LOAD\_SS}$$

where  $dV/dt_{SS} = 18mV/\mu s$  is the soft-start ramp rate and  $I_{LOAD\_SS}$  is the load current during soft-start. Choose a  $C_{OUT}$  that keeps the inductor current average below 3A, or even lower.

### Setting the Output Voltage

The KTB8400 has two independent output voltage ranges. The low range is  $V_{OUT} = 0.6V$  to 1.39375V in 6.25mV steps. The high range is  $V_{OUT} = 1.44V$  to 3.345V in 15mV steps. The range is I<sup>2</sup>C programmable using the RANGE bit (B3) in the CONTROL configuration register (0x02). The default range setting is factory trimmed to match the default output voltage setting – see the *Ordering Information* section.

After the correct range is selected, the KTB8400 register map contains two voltage setting registers to facilitate hardware control of DVS using the VSEL pin. The first output voltage setting is I<sup>2</sup>C programmable using the VOUT\_VSEL0[6:0] bits (B6:0) in the VSEL0 configuration register (0x00). The second output voltage setting is I<sup>2</sup>C programmable using the VOUT\_VSEL1[6:0] bits (B6:0) in the VSEL1 configuration register (0x01). The output voltage setting is given by:

$$V_{OUT} = G \times (600mV + 6.25mV \times VOUT\_VSELn)$$

where  $G = 1.0$  when the RANGE bit is 0, and  $G = 2.4$  when the RANGE bit is 1.  $V_{OUT\_VSELn}$  is the decimal equivalent of the binary bits of  $V_{OUT\_VSEL0}[6:0]$  or  $V_{OUT\_VSEL1}[6:0]$ . The default voltage settings are factory trimmed, and several versions are available – see the *Ordering Information* section.

## Dynamic Voltage Scaling (DVS)

Dynamic Voltage Scaling (DVS) is used to slew the output voltage between two voltage settings contained in the VSEL0 and VSEL1 registers – see *Setting the Output Voltage* section. The VSEL pin selects which register is used. Or, as an alternative method, I<sup>2</sup>C commands can be used by simply connecting the VSEL pin to ground and dynamically writing a new setting into the VSEL0 register.

In either method, all DVS output voltage transitions are slew-rate-controlled by an on-chip up/down counter and DAC. The DVS slew rate is I<sup>2</sup>C programmable using the SLEW[2:0] bits (B6:4) in the CONTROL configuration register (0x02). DVS slewing is only possible within a single output voltage range; slewing between a voltage in the low range and a voltage in the high range is **not** possible.

## Forced-PWM vs. Auto-Skip Modes

The KTB8400 has two ways to control light-load switching behavior – Forced-PWM mode and Auto-Skip mode. In Forced-PWM, the switching frequency remains nearly constant. This mode is helpful for applications that are noise sensitive.

In Auto-Skip mode, the KTB8400 transitions automatically between PWM switching at heavy loads and Skip/PFM switching at light loads. Auto-Skip mode is helpful for applications that need high efficiency at light loads. While skipping, single pulses are evenly spaced, resulting in the lowest output ripple and noise when compared to competing “pulse-grouping” or “burst mode” devices. Furthermore, the PFM frequency during single-pulse skipping remains above the audio frequency band (20Hz to 20kHz) down to very light loads – see the *Typical Operating Characteristics* section.

Auto-Skip mode can be disabled (set Forced-PWM mode) by programming the MODE[1:0] bits (B1:0) in the CONTROL configuration register (0x02) in combination with the state of the VSEL pin or simply by setting the MODE pin high. See Table 1. The default mode settings are factory trimmed, and several versions are available – see the *Ordering Information* section.

**Table 1. Hardware/Software Enable and Operation Mode**

Control Pins			ENx Bits		Mode Bits [1:0]	Operation	V <sub>OUT</sub>
EN	VSEL	MODE	EN0	EN1			
0	X	X	X	X	XX	Shutdown	N/A
1	X	X	0	0	XX	Shutdown	N/A
1	0	0	1	X	X0	Auto-Skip	V <sub>OUT_VSEL0</sub>
1	0	0	1	X	X1	Forced-PWM	V <sub>OUT_VSEL0</sub>
1	1	0	X	1	0X	Auto-Skip	V <sub>OUT_VSEL1</sub>
1	1	0	X	1	1X	Forced-PWM	V <sub>OUT_VSEL1</sub>
1	0	X	0	X	XX	Shutdown	N/A
1	0	1	1	X	XX	Forced-PWM	V <sub>OUT_VSEL0</sub>
1	1	X	X	0	XX	Shutdown	N/A
1	1	1	X	1	XX	Forced-PWM	V <sub>OUT_VSEL1</sub>

## Active Discharge

When the KTB8400 buck is disabled, an active discharge feature connects an on-chip resistor ( $R_{LX\_DIS}$ ) between the LX and PGND pins. This resistor discharges the output capacitor through the inductor. By default, this feature is enabled; however, it can be disabled for applications that require a high impedance at the output during shutdown. Enable and disable the active discharge feature via I<sup>2</sup>C commands by writing the DIS bit (B7) in the CONTROL configuration register (0x02).

## POR and Software Register Reset

The KTB8400 does NOT contain non-volatile memory for the register settings. When  $V_{IN}$  rises above  $V_{POR} = 1.8V$ , either at initial power up or after a temporary  $V_{IN}$  droop below  $V_{POR}$ , a Power-On Reset (POR) circuit resets all registers to their factory default settings. Thereafter, as long as  $V_{IN}$  remains above  $V_{POR}$ , the I<sup>2</sup>C registers contents are retained, regardless if the buck is enabled or disabled. However, to reliably read or write to the I<sup>2</sup>C registers,  $V_{IN}$  should be above  $V_{UVLO}$ .

To reset the registers manually via software, use I<sup>2</sup>C to write a 1 to the RESET bit (B2) in the CONTROL configuration register (0x02). This resets nearly all registers to their default settings. There are a few exceptions, as makes logical sense; refer to the CONTROL register description.

## Internal Status Monitor

The KTB8400 contains a MONITOR status register (0x05), which can be read to check the present status of the IC. The register has individual bits for the status of  $V_{OUT}$  power-OK,  $V_{IN}$  under-voltage lockout,  $V_{IN}$  over-voltage protection,  $V_{OUT}$  positive slew,  $V_{OUT}$  negative slew, software reset event latch, over-temperature thermal shutdown, and buck enable. Refer to the MONITOR register description for more details.

## Input Under-Voltage Lockout (UVLO)

When the input voltage ( $V_{IN}$ ) is below the under-voltage lockout threshold ( $V_{UVLO}$ ), the buck is disabled. The I<sup>2</sup>C registers and all logic pins remain functional during UVLO, so long as  $V_{IN}$  remains above  $V_{POR} = 1.8V$ . Exiting UVLO does **not** reset any registers. When  $V_{IN}$  rises above  $V_{UVLO}$ , either at initial power up or after a temporary  $V_{IN}$  droop below  $V_{UVLO}$ , and if the buck is enabled, the programmed soft-start ramp begins.

The UVLO status is reflected in the MONITOR register. UVLO events do **not** reset the registers to their defaults.  $V_{IN}$  must fall below  $V_{POR}$  to reset the registers.

## Input Over-Voltage Protection (OVP)

When the input voltage ( $V_{IN}$ ) is above the over-voltage protection threshold ( $V_{OVP}$ ), the buck is disabled. The I<sup>2</sup>C registers and all logic pins remain functional during OVP. When  $V_{IN}$  returns below  $V_{OVP}$ , and if the buck is enabled, the programmed soft-start ramp begins.

Just like UVLO, the OVP status is reflected in the MONITOR register.

## Inductor Over-Current Protection (OCP)

Inductor peak current limit ( $I_{LX\_PEAK}$ ) and valley current limit ( $I_{LX\_VALLEY}$ ) protect the buck and inductor during over-current faults. The current limits control the buck's switching on a cycle-by-cycle basis and have a higher priority than the voltage regulation threshold.

During sustained over-current faults, the output voltage typically droops below the regulation threshold. The POK\_STAT bit (B7) in the MONITOR register (0x05) indicates when  $V_{OUT}$  is okay (**above** the  $V_{OUT\_POK}$  threshold).

## Output Short-Circuit Protection (SCP) and Hiccup Mode

During a short-circuit event at the buck's output, the inductor experiences a very low discharge voltage during the switching cycle's off-time ( $t_{OFF}$ , when the synchronous rectifier switch is on). In this case, the inductor current ramps down very slowly. In order to prevent inductor current runaway, the valley current limit ( $I_{LX\_VALLEY}$ ) extends  $t_{OFF}$ , keeping the inductor current well controlled.

If an over-current fault or short-circuit event persists for more than 250 $\mu$ s, the buck enters hiccup mode and pause all switching. After about 5ms, the buck attempts to soft-start. If the fault persists, the buck once again enters hiccup mode and periodically re-attempts soft-start until the fault is removed. The low duty-factor during hiccup mode prevents the IC from getting hot.

## Thermal Shutdown Over-Temperature (OT)

Over-temperature (OT) protection occurs if the die junction temperature exceeds the thermal shutdown threshold ( $T_{J\_SHDN}$ ). During thermal shutdown, the buck pauses all switching until the die temperature cools. Once cooled, the buck re-starts with the programmed soft-start ramp.

The OT status is reflected in the MONITOR register.

## Trim Options

The KTB8400 is factory trimmed using one-time programmable (OTP) registers. Standard versions are available for various default output voltage settings and modes – see the *Ordering Information* section. Contact a Kinetic Technologies representative regarding versions with other default settings or I<sup>2</sup>C slave addresses.

## I<sup>2</sup>C Interface Description

### I<sup>2</sup>C Serial Data Bus

The KTB8400 supports the I<sup>2</sup>C bus protocol. A device that sends data onto the bus is defined as a transmitter, and a device receiving data as a receiver. The device that controls the bus is called a master, whereas the devices controlled by the master are known as slaves. A master device must generate the serial clock (SCL), control bus access and generate START and STOP conditions to control the bus. The KTB8400 operates as a slave on the I<sup>2</sup>C bus. Within the bus specifications, a standard mode (100kHz maximum clock rate) and a fast mode (400kHz maximum clock rate) are defined. The KTB8400 works in both modes. Connections to the bus are made through the open-drain I/O lines SDA and SCL.

The following bus protocol has been defined in Figure 2:

- Data transfer may be initiated only when the bus is not busy.
- During data transfer, the data line must remain stable whenever the clock line is HIGH. Changes in the data line while the clock line is high are interpreted as control signals.

Accordingly, the following bus conditions have been defined:

#### Bus Not Busy

Both data and clock lines remain HIGH.

#### Start Data Transfer

A change in the state of the data line, from HIGH to LOW, while the clock is HIGH, defines a START condition.

#### Stop Data Transfer

A change in the state of the data line, from LOW to HIGH, while the clock line is HIGH, defines the STOP condition.

#### Data Valid

The state of the data line represents valid data when, after a START condition, the data line is stable for the duration of the HIGH period of the clock signal. The data on the line must be changed during the LOW period of the clock signal. There is one clock pulse per bit of data.

Each data transfer is initiated with a START condition and terminated with a STOP condition. The number of data bytes transferred between START and STOP conditions are not limited, and are determined by the master device. The information is transferred byte-wise and each receiver acknowledges with a ninth bit.

#### Acknowledge

Each receiving device, when addressed, is obliged to generate an acknowledge after the reception of each byte. The master device must generate an extra clock pulse that is associated with this acknowledge bit.

A device that acknowledges must pull down the SDA line during the acknowledge clock pulse in such a way that the SDA line is stable LOW during the HIGH period of the acknowledge-related clock pulse. Setup and hold times must also be taken into account.

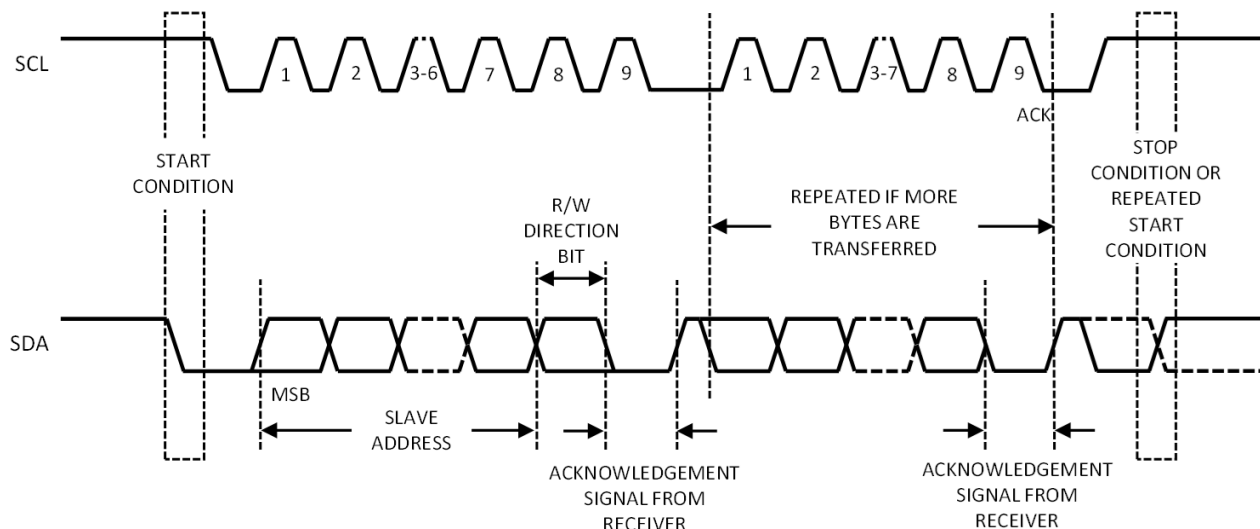

**Figure 2. Data Transfer on I<sup>2</sup>C Serial Bus**

The KTB8400 7-bit slave device address is listed in the Ordering Information table in page 3.

There are two kinds of I<sup>2</sup>C data transfer cycles: write cycle and read cycle.

### I<sup>2</sup>C Write Cycle

For I<sup>2</sup>C write cycle, data is transferred from a master to a slave. The first byte transmitted is the 7-bit slave address plus one bit of '0' for write. Next follows a number of data bytes. The slave returns an acknowledge bit after each received byte. Data is transferred with the most significant bit (MSB) first. Figure 3 shows the sequence of the I<sup>2</sup>C write cycle.

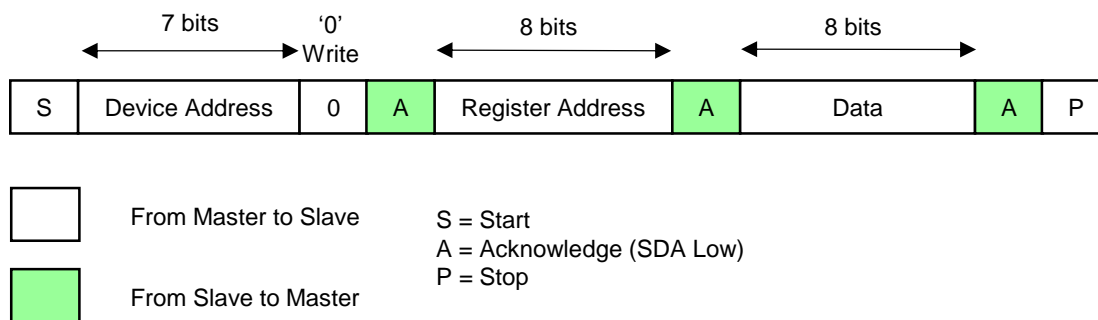

**Figure 3. I<sup>2</sup>C Write Cycle**

#### I<sup>2</sup>C Write Cycle Steps:

- Master generates start condition.
- Master sends 7-bit slave address and 1-bit data direction '0' for write.
- Slave sends acknowledge if the slave address is matched.
- Master sends 8-bit register address.
- Slave sends acknowledge.
- Master sends 8-bit data for that addressed register.
- Slave sends acknowledge.
- If master sends more data bytes, the register address will be incremented by one after each acknowledge.
- Master generate stop condition to finish the write cycle.

## I<sup>2</sup>C Read Cycle

For I<sup>2</sup>C read cycle, data is transferred from a slave to a master. But to start the read cycle, master needs to write the register address first to define which register data to read. Figure 4 shows the steps of the I<sup>2</sup>C read cycle.

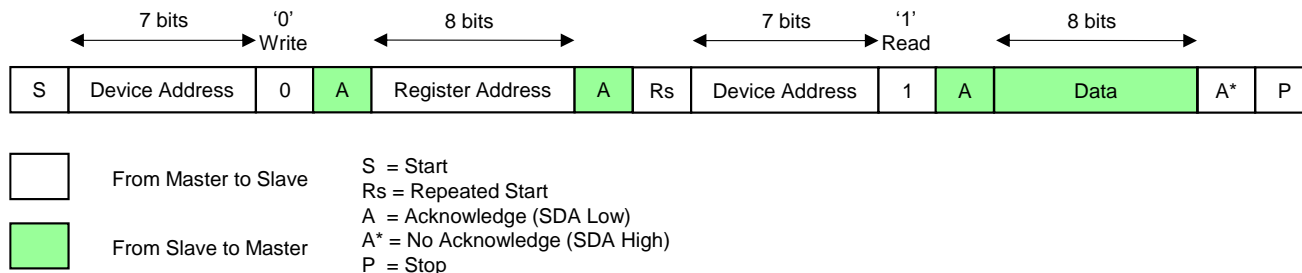

**Figure 4. I<sup>2</sup>C Read Cycle**

### I<sup>2</sup>C Read Cycle Steps:

- Master generates start condition.
- Master sends 7-bit slave address and 1-bit data direction '0' for write.
- Slave sends acknowledge if the slave address is matched.
- Master sends 8-bit register address.
- Slave sends acknowledge.
- Master generates repeated start condition.
- Master sends 7-bit slave address and 1-bit data direction '1' for read.
- Slave sends acknowledge if the slave address is matched.
- Slave sends the data byte of that addressed register.
- If master sends acknowledge, the register address will be incremented by one after each acknowledge and the slave will continue to send the data for the updated addressed register.
- If master sends no acknowledge, the slave will stop sending the data.
- Master generate stop condition to finish the read cycle.



## I<sup>2</sup>C Registers

### I<sup>2</sup>C Slave Address

Options <sup>9</sup>	7-Bit Address	Write Address	Read Address	Bits 7 6 5 4 3 2 1 0
KTB8400M	0x60	0xC0	0xC1	1 1 0 0 0 0 0 <i>R/W</i>

### I<sup>2</sup>C Register Map

Hex Address	Name	Type	Access	Default Reset	B7	B6	B5	B4	B3	B2	B1	B0
0x00	VSEL0	Config	R/W	1xxx xxxx	EN0	VOUT_VSEL0[6:0]						
0x01	VSEL1	Config	R/W	1xxx xxxx	EN1	VOUT_VSEL1[6:0]						
0x02	CONTROL	Config	R/W	1000 x0xx	DIS	SLEW[2:0]		RANGE	RESET	MODE[1:0]		
0x03	ID1	Data	R	1010 0010	VENDOR[2:0]			DIE_ID[4:0]				
0x04	ID2	Status	R	0000 xxxx	RSVD	RSVD	RSVD	RSVD	DIE_REV[3:0]			
0x05	MONITOR	Status	R	0000 0000	POK _STAT	UVLO _STAT	OVP _STAT	POS _STAT	NEG _STAT	RESET _STAT	OT _STAT	EN _STAT

Register contents are reset in hardware to their default values by V<sub>IN</sub> power-on reset. Additionally, most registers can be reset in software by writing 1 to the RESET bit (B2) in the CONTROL register (0x02). Default Reset bits marked with lower-case “x” in the register map and register details tables depend upon the ordered part# suffix and die revision; please see the *Ordering Information* section. Upper-case “X” used elsewhere in the tables designates “don’t care”.

### VSEL0 Configuration Register

Register Address 0x00

Bit	Name	Access	Default Reset	Description																
7	EN0	R/W	1	Software Buck Enable. When EN pin is low, the regulator is off. When EN pin is high and VSEL pin is low, the EN0 bit takes precedent. <table border="1" style="margin-left: 20px;"> <thead> <tr> <th>EN pin</th> <th>VSEL pin</th> <th>EN0 bit</th> <th>Regulator</th> </tr> </thead> <tbody> <tr> <td>0</td> <td>X</td> <td>X</td> <td>off</td> </tr> <tr> <td>1</td> <td>0</td> <td>0</td> <td>off</td> </tr> <tr> <td>1</td> <td>0</td> <td>1</td> <td>on</td> </tr> </tbody> </table>	EN pin	VSEL pin	EN0 bit	Regulator	0	X	X	off	1	0	0	off	1	0	1	on
EN pin	VSEL pin	EN0 bit	Regulator																	
0	X	X	off																	
1	0	0	off																	
1	0	1	on																	
6:0	VOUT_VSEL0[6:0]	R/W	xxx xxxx	Sets the nominal V <sub>OUT</sub> regulation voltage when VSEL pin is low. When RANGE bit is low, the V <sub>OUT</sub> range is from 0.600 to 1.39375V. When RANGE bit is high, the V <sub>OUT</sub> range is from 1.440 to 3.345V. $V_{OUT} = G \times (600mV + 6.25mV \times VOUT\_VSEL0)$ where G = 1.0 when RANGE bit is low, and G = 2.4 when RANGE bit is high.																

9. For Alternate 1/2/3 Slave Addresses, please contact a Kinetic Technologies representative.



## VSEL1 Configuration Register

Register Address 0x01

Bit	Name	Access	Default Reset	Description																
7	EN1	R/W	1	<p>Software Buck Enable. When EN pin is low, the regulator is off. When EN pin is high and VSEL pin is high, the EN1 bit takes precedent.</p> <table border="1"> <thead> <tr> <th>EN pin</th> <th>VSEL pin</th> <th>EN1 bit</th> <th>Regulator</th> </tr> </thead> <tbody> <tr> <td>0</td> <td>X</td> <td>X</td> <td>off</td> </tr> <tr> <td>1</td> <td>1</td> <td>0</td> <td>off</td> </tr> <tr> <td>1</td> <td>1</td> <td>1</td> <td>on</td> </tr> </tbody> </table>	EN pin	VSEL pin	EN1 bit	Regulator	0	X	X	off	1	1	0	off	1	1	1	on
EN pin	VSEL pin	EN1 bit	Regulator																	
0	X	X	off																	
1	1	0	off																	
1	1	1	on																	
6:0	VOUT_VSEL1[6:0]	R/W	xxx xxxx	<p>Sets the nominal <math>V_{OUT}</math> regulation voltage when VSEL pin is high. When RANGE bit is low, the <math>V_{OUT}</math> range is from 0.600 to 1.39375V. When RANGE bit is high, the <math>V_{OUT}</math> range is from 1.440 to 3.345V.</p> $V_{OUT} = G \times (600mV + 6.25mV \times VOUT\_VSEL1)$ <p>where <math>G = 1.0</math> when RANGE bit is low, and <math>G = 2.4</math> when RANGE bit is high.</p>																

## CONTROL Configuration Register

Register Address 0x02

Bit	Name	Access	Default Reset	Description																																																																				
7	DIS	R/W	1	<p>Active Discharge of LX when regulator is disabled. Discharging LX will discharge <math>C_{OUT}</math> through the inductor.            0 = <math>V_{OUT}</math> is high impedance when disabled.            1 = <math>V_{OUT}</math> is discharged through an internal pull-down resistor when disabled.</p>																																																																				
6:4	SLEW[2:0]	R/W	000	<p>Slew Rate Control for DVS ramp-up/down rates. Works in conjunction with the RANGE bit.</p> <table border="1"> <thead> <tr> <th>RANGE bit</th> <th>SLEW bits</th> <th>DVS</th> <th><math>f_{STEP}</math></th> </tr> </thead> <tbody> <tr><td>0</td><td>000</td><td>3.125mV/<math>\mu</math>s</td><td>500kHz</td></tr> <tr><td>0</td><td>001</td><td>3.125mV/<math>\mu</math>s</td><td>500kHz</td></tr> <tr><td>0</td><td>010</td><td>6.25mV/<math>\mu</math>s</td><td>1MHz</td></tr> <tr><td>0</td><td>011</td><td>6.25mV/<math>\mu</math>s</td><td>1MHz</td></tr> <tr><td>0</td><td>100</td><td>12.5mV/<math>\mu</math>s</td><td>2MHz</td></tr> <tr><td>0</td><td>101</td><td>12.5mV/<math>\mu</math>s</td><td>2MHz</td></tr> <tr><td>0</td><td>110</td><td>25mV/<math>\mu</math>s</td><td>4MHz</td></tr> <tr><td>0</td><td>111</td><td>25mV/<math>\mu</math>s</td><td>4MHz</td></tr> <tr><td>1</td><td>000</td><td>3.75mV/<math>\mu</math>s</td><td>250kHz</td></tr> <tr><td>1</td><td>001</td><td>3.75mV/<math>\mu</math>s</td><td>250kHz</td></tr> <tr><td>1</td><td>010</td><td>7.5mV/<math>\mu</math>s</td><td>500kHz</td></tr> <tr><td>1</td><td>011</td><td>7.5mV/<math>\mu</math>s</td><td>500kHz</td></tr> <tr><td>1</td><td>100</td><td>15mV/<math>\mu</math>s</td><td>1MHz</td></tr> <tr><td>1</td><td>101</td><td>15mV/<math>\mu</math>s</td><td>1MHz</td></tr> <tr><td>1</td><td>110</td><td>25mV/<math>\mu</math>s</td><td>2MHz</td></tr> <tr><td>1</td><td>111</td><td>25mV/<math>\mu</math>s</td><td>2MHz</td></tr> </tbody> </table>	RANGE bit	SLEW bits	DVS	$f_{STEP}$	0	000	3.125mV/ $\mu$ s	500kHz	0	001	3.125mV/ $\mu$ s	500kHz	0	010	6.25mV/ $\mu$ s	1MHz	0	011	6.25mV/ $\mu$ s	1MHz	0	100	12.5mV/ $\mu$ s	2MHz	0	101	12.5mV/ $\mu$ s	2MHz	0	110	25mV/ $\mu$ s	4MHz	0	111	25mV/ $\mu$ s	4MHz	1	000	3.75mV/ $\mu$ s	250kHz	1	001	3.75mV/ $\mu$ s	250kHz	1	010	7.5mV/ $\mu$ s	500kHz	1	011	7.5mV/ $\mu$ s	500kHz	1	100	15mV/ $\mu$ s	1MHz	1	101	15mV/ $\mu$ s	1MHz	1	110	25mV/ $\mu$ s	2MHz	1	111	25mV/ $\mu$ s	2MHz
RANGE bit	SLEW bits	DVS	$f_{STEP}$																																																																					
0	000	3.125mV/ $\mu$ s	500kHz																																																																					
0	001	3.125mV/ $\mu$ s	500kHz																																																																					
0	010	6.25mV/ $\mu$ s	1MHz																																																																					
0	011	6.25mV/ $\mu$ s	1MHz																																																																					
0	100	12.5mV/ $\mu$ s	2MHz																																																																					
0	101	12.5mV/ $\mu$ s	2MHz																																																																					
0	110	25mV/ $\mu$ s	4MHz																																																																					
0	111	25mV/ $\mu$ s	4MHz																																																																					
1	000	3.75mV/ $\mu$ s	250kHz																																																																					
1	001	3.75mV/ $\mu$ s	250kHz																																																																					
1	010	7.5mV/ $\mu$ s	500kHz																																																																					
1	011	7.5mV/ $\mu$ s	500kHz																																																																					
1	100	15mV/ $\mu$ s	1MHz																																																																					
1	101	15mV/ $\mu$ s	1MHz																																																																					
1	110	25mV/ $\mu$ s	2MHz																																																																					
1	111	25mV/ $\mu$ s	2MHz																																																																					

Bit	Name	Access	Default Reset	Description															
3	RANGE	R/W	x	<p>Sets the <math>V_{OUT}</math> range. Also influences the DVS ramp-up/down slew rate (see SLEW[2:0] above).</p> <table border="1"> <thead> <tr> <th>RANGE bit</th> <th>G</th> <th><math>V_{OUT(min)}</math></th> <th><math>V_{OUT(max)}</math></th> <th><math>V_{OUT(step)}</math></th> </tr> </thead> <tbody> <tr> <td>0</td> <td>1.0</td> <td>0.600V</td> <td>1.39375V</td> <td>6.25mV</td> </tr> <tr> <td>1</td> <td>2.4</td> <td>1.440V</td> <td>3.345V</td> <td>15mV</td> </tr> </tbody> </table> $V_{OUT} = G \times (600mV + 6.25mV \times V_{OUT\_VSELn})$ <p>where G = 1.0 when RANGE bit is low, and G = 2.4 when RANGE bit is high.            Note: There is no slew-rate control when toggling the RANGE bit; therefore, it is recommended to disable <math>V_{OUT}</math> before changing the RANGE setting.</p>	RANGE bit	G	$V_{OUT(min)}$	$V_{OUT(max)}$	$V_{OUT(step)}$	0	1.0	0.600V	1.39375V	6.25mV	1	2.4	1.440V	3.345V	15mV
RANGE bit	G	$V_{OUT(min)}$	$V_{OUT(max)}$	$V_{OUT(step)}$															
0	1.0	0.600V	1.39375V	6.25mV															
1	2.4	1.440V	3.345V	15mV															
2	RESET	R/W	0	<p>Software Reset to default register settings. Writing 1 resets <i>nearly</i> all the registers. The RESET bit always reads back as 0. Before self-clearing, the software reset event is latched into the RESET_STAT bit (B2) in the MONITOR register (0x05) and also into the RESET_INT bit (B2) in the INTLATCH register (0x07) if unmasked.</p> <p>Items that are <b>NOT</b> reset by the RESET bit are:</p> <ol style="list-style-type: none"> <li>RESET_STAT bit in the MONITOR register</li> <li>RESET_INT bit in the INTLATCH register</li> </ol>															
1:0	MODE[1:0]	R/W	xx	<p>Auto-Skip vs. Forced-PWM mode control. Works in conjunction with the VSEL and MODE pin. Auto-Skip automatically uses PWM in continuous conduction at heavy loads and PFM pulse-skipping in discontinuous conduction at light loads. The bits are don't-care if the Mode pin is high. Refer to Table 2.</p>															

## ID1 Data Register

Register Address 0x03

Bit	Name	Access	Default Reset	Description
7:5	VENDOR[2:0]	R	101	Vendor Identification 101 = Kinetic Technologies
4:0	DIE_ID[4:0]	R	0 0010	Die Type Identification 0 0010 = KTB8400

## ID2 Status Register

Register Address 0x04

Bit	Name	Access	Default Reset	Description
7	RSVD	R	0	Reserved. Always reads back as 0.
6	RSVD	R	0	Reserved. Always reads back as 0.
5	RSVD	R	0	Reserved. Always reads back as 0.
4	RSVD	R	0	Reserved. Always reads back as 0.
3:0	DIE_REV[3:0]	R	xxxx	Die Revision Identification

**MONITOR Status Register**

Register Address 0x05

Bit	Name	Access	Default Reset	Description
7	POK_STAT	R	0	<p>V<sub>OUT</sub> Power OK Status</p> <p>0 = V<sub>OUT</sub> is below POK comparator threshold</p> <p>1 = V<sub>OUT</sub> is above POK comparator threshold</p> <p>During normal operation, the POK_STAT bit is 1. During disabled, soft-start or overload conditions, the POK_STAT bit is 0.</p>
6	UVLO_STAT	R	0	<p>V<sub>IN</sub> Under-Voltage Status</p> <p>0 = V<sub>IN</sub> is above the UVLO comparator threshold</p> <p>1 = V<sub>IN</sub> is below the UVLO comparator threshold</p> <p>During normal operation or when disabled, the UVLO_STAT bit is 0. During low input voltage conditions, the buck is disabled by the UVLO comparator and the UVLO_STAT bit is set to 1 (so long as V<sub>IN</sub> remains above V<sub>POR</sub>=1.8V).</p>
5	OVP_STAT	R	0	<p>V<sub>IN</sub> Over-Voltage Status</p> <p>0 = V<sub>IN</sub> is below the OVP comparator threshold</p> <p>1 = V<sub>IN</sub> is above the OVP comparator threshold</p> <p>During normal operation or when disabled, the OVP_STAT bit is 0. During high input voltage conditions, the buck is disabled by the OVP comparator and the OVP_STAT bit is set to 1.</p>
4	POS_STAT	R	0	<p>V<sub>OUT</sub> Positive Slew Status</p> <p>0 = V<sub>OUT</sub> is at its set value</p> <p>1 = V<sub>OUT</sub> is slewing in the positive direction towards its set value</p> <p>During normal operation, the POS_STAT bit is 0. During soft-start or positive DVS slew transitions, the POS_STAT bit is 1.</p>
3	NEG_STAT	R	0	<p>V<sub>OUT</sub> Negative Slew Status</p> <p>0 = V<sub>OUT</sub> is at its set value</p> <p>1 = V<sub>OUT</sub> is slewing in the negative direction towards its set value</p> <p>During normal operation, the NEG_STAT bit is 0. During negative DVS slew transitions, the NEG_STAT bit is 1.</p>
2	RESET_STAT	R/C	0	<p>Software Reset Status Latch</p> <p>0 = software reset was not performed since this bit was cleared</p> <p>1 = software reset was performed since this bit was cleared</p> <p>The RESET_STAT bit is set to 1 when a software reset is written to the RESET bit (B2) in the CONTROL register. The RESET_STAT bit is <b>NOT</b> reset by the software reset. Instead, it is cleared (reset to 0) after the RESET_STAT bit is read or whenever chip power is removed (V<sub>IN</sub>&lt;V<sub>POR</sub>).</p>
1	OT_STAT	R	0	<p>Over-Temperature Status</p> <p>0 = the die is not in thermal shutdown</p> <p>1 = the die is in thermal shutdown</p> <p>During normal operation, the OT_STAT bit is 0. During thermal shutdown, the OT_STAT bit is 1.</p>
0	EN_STAT	R	0	<p>Enable Status</p> <p>0 = the buck is disabled by hardware or software</p> <p>1 = the buck is enabled by hardware or software</p> <p>During normal operation, the EN_STAT bit is 1. During hardware or software disabled conditions, the EN_STAT bit is 0.</p>

## Applications Information

### Recommended Inductors

The KTB8400 is trimmed for inductors with nominal inductance of 330nH or 470nH. Select an inductor with a saturation current rating that is higher than the KTB8400 peak current limit. Also, choose an inductor with sufficient temperature-rise current rating to satisfy the RMS load-current of the application. Consider the inductor's resistance (both DCR and ACR at 2.4MHz), since these will affect the efficiency. (Generally, the ACR vs. frequency characteristic is available upon request from the inductor supplier.) Larger physical case-sizes, good winding designs, and better magnetic materials can increase efficiency. Typically, metric 2012 and 2016 case-sizes are suitable. Table 2 is a list of recommended inductors from two leading suppliers.

**Table 2. Recommended Inductors**

Maker	Part #	L (typ)	DCR (typ)	ISAT (min)	I <sub>ΔT+40C</sub> (min)	Size (typ/typ/max)
Murata	DFE201210U-R33M	330nH	25mΩ	5.2A	3.4A	2.0 x 1.2 x 1.0mm
	DFE201210U-R47M	470nH	34mΩ	4.4A	3.0A	
Murata	DFE201610E-R33M	330nH	21mΩ	5.5A	4.0A	2.0 x 1.6 x 1.0mm
	DFE201610E-R47M	470nH	26mΩ	4.8A	3.6A	
Murata	DFE201612E-R33M	330nH	15mΩ	6.3A	4.8A	2.0 x 1.6 x 1.2mm
	DFE201612E-R47M	470nH	20mΩ	5.5A	4.5A	
Samsung E-M	CIGT201208EHR47MNE	470nH	31mΩ	4.1A	3.7A	2.0 x 1.25 x 0.8mm
Samsung E-M	CIGT201210UHR33MNE	330nH	21mΩ	5.4A	4.0A	2.0 x 1.25 x 1.0mm
	CIGT201210UHR47MNE	470nH	25mΩ	4.9A	3.6A	
Samsung E-M	CIGT201608EHR47MNE	470nH	24mΩ	4.3A	4.3A	2.0 x 1.6 x 0.8mm
Samsung E-M	CIGW201610GHR33MLE	330nH	18mΩ	5.5A	4.0A	2.0 x 1.6 x 1.0mm
	CIGW201610GLR47MLE	470nH	21mΩ	5.0A	4.7A	
	CIGT201610EHR47MNE	470nH	18mΩ	5.5A	4.8A	

### Recommended Capacitors

Ceramic input and output capacitors with X5R or X6S are recommended due to their low ESR, low ESL, low temperature coefficients, and small physical sizes. Consider the voltage rating, size, and DC bias derating characteristic of the capacitor. **Table 3** is a list of recommended capacitors from two leading suppliers.

**Table 3. Recommended Capacitors**

Maker	Part #	C (typ)	C <sub>EFF(3V)</sub>	V <sub>RATING</sub>	T <sub>CHAR</sub>	Size
Murata	GRM155R60J106ME	10μF	3.5μF	6.3V	X5R	(0402) 1.0 x 0.5mm
	GRM155R60J156ME	15μF	5μF	6.3V		
	GRM155R60G226ME	22μF	7μF	4.0V		
	GRM155R60J226ME	22μF	7μF	6.3V		
Murata	GRM188R60G226ME	22μF	9μF	4.0V	X5R	(0603) 1.6 x 0.8mm
	GRM188R60J226ME	22μF	9μF	6.3V		
Samsung E-M	CL05A106MQ5	10μF	4μF	6.3V	X5R	(0402) 1.0 x 0.5mm
	CL05A156MQ5	15μF	6μF	6.3V		
Samsung E-M	CL10A226MQ8	22μF	11μF	6.3V	X5R	(0603) 1.6 x 0.8mm
	CL10A476MQ8	47μF	14μF	6.3V		

### Input Capacitor

Choose an input capacitor with voltage rating of 6.3V or more, 10μF total nominal capacitance or more, and 1005M (0402) case-size or larger. Larger values and larger case-size provide more effective capacitance when considering the DC bias derating characteristic of the capacitor. If the application's input voltage is supplied through a connector or a cable, add additional bypass/bulk capacitance where V<sub>IN</sub> first arrives to the PCB.

### Output Capacitors

Choose output capacitors with voltage rating of 4.0V or more, 20μF total nominal capacitance or more, and 1005M (0402) case-size or larger. Consider the V<sub>OUT</sub> setting of the regulator and how case size has a significant impact

on DC bias derating. At high  $V_{OUT}$  settings, more total nominal capacitance is needed to achieve the same effective capacitance compared to lower  $V_{OUT}$  settings.

For the very best possible load transient response, use multiple capacitors in parallel to achieve sufficient total effective output capacitance:

$$C_{OUT_{EFFECTIVE}} \geq \frac{L \times I_{STEP}}{33m\Omega \times (V_{IN} - V_{OUT})}$$

where  $I_{STEP}$  is the largest load transient step in the application. Please note that the above formula is already guard-banded by a margin of 2x to accommodate capacitor and inductor tolerances and the variability of a transient arrival time with respect to the switching cycle of the regulator.

If needed, the total effective output capacitance can be distributed by placing additional capacitors remotely at the point of load. In applications where transient performance is less critical, especially when  $V_{IN}$  minus  $V_{OUT}$  is small, it is acceptable to reduce the total effective output capacitance to save board space and cost at the expense of load transient droop and soar.

As a design example, consider a system with  $V_{IN} = 3.2V$  (min),  $V_{OUT} = 1.8V$ , and  $I_{STEP} = 2A$  (max):

$$C_{OUT_{EFFECTIVE}} \geq \frac{330nH \times 2A}{33m\Omega \times (3.2V - 1.8V)} \cong 14\mu F$$

In this example, choose output capacitors with total effective capacitance of  $14\mu F$  or more at a DC bias of  $1.8V$ . A single  $15\mu F$  capacitor will not be enough when considering its DC bias characteristic, per Figure 5. At  $1.8V$  bias, it retains only about  $8\mu F$ ; therefore, for best transient response, use two of these capacitors in parallel for a total effective capacitance of  $16\mu F$ .

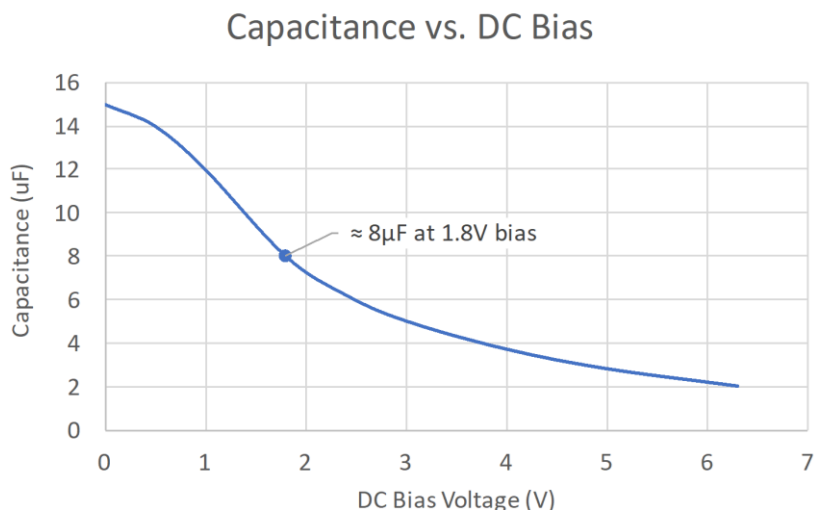

**Figure 5. Typical DC bias derating characteristic for example  $15\mu F$  ceramic capacitor.**

When operating near dropout with high  $V_{OUT}$  and low  $V_{IN}$  (for example  $3.3V_{OUT}$  and  $3.6V_{IN}$ ), add additional bulk capacitance to  $C_{OUT}$  to reduce  $V_{OUT}$  droop and ringing during load transient events that is inherent in buck regulators operating at high duty-cycle.

## Recommended PCB Layout

Refer to Figure 6 for two example PCB layouts optimized for small footprint, low EMI, and good performance. One example fits in a narrow rectangular area, while the other example is nearly square. Both examples follow the below PCB layout recommendations:

1. Connect the input capacitor  $C_{IN}$  as close as possible to the VIN and PGND pins using top-side thick metal traces.
2. Connect the ground terminals of output capacitors  $C_{OUT}$  as close as possible to the ground terminal of  $C_{IN}$  and the PGND pins using top-side metal.
3. Connect the local top-side PGND island to the PCB ground plane using multiple parallel vias.
4. Do not connect the AGND pins directly to the top-side PGND. Instead, connect the AGND pins to the PCB ground plane using their own vias.
5. Connect the inductor to the LX pins with a wide trace. For smallest  $C_{IN}$ , the LX trace will not fit between the top-side landing pads of a 1005M (0402) size capacitor. Therefore, the LX trace is normally routed on PCB layer 2 or layer 3 using multiple parallel vias.
  - a. The added inductance of vias in series with the actual inductor have minimal effect on performance. However, it is important to use enough parallel vias to handle the peak inductor current in the application.
  - b. If using a larger  $C_{IN}$  of 1608M (0603) size or more, it is possible to squeeze the LX route on the top-side between the  $C_{IN}$  landing pads. If pinched, make sure to widen the LX trace as much as possible before and after the pinched area.
6. Connect the  $V_{OUT}$  terminals of the inductor to the output capacitors with a wide and short trace.
7. Route the  $V_{OUT}$  sense trace from  $C_{OUT}$  to the VOUT pin with care to keep it away from noisy traces, especially the LX trace. Additionally, use ground fill to shield noise from coupling into the  $V_{OUT}$  sense.
8. Depending upon PCB design rules, it may be possible to place filled micro-vias directly under WLCSP bumps. If not, route short traces to nearby vias.

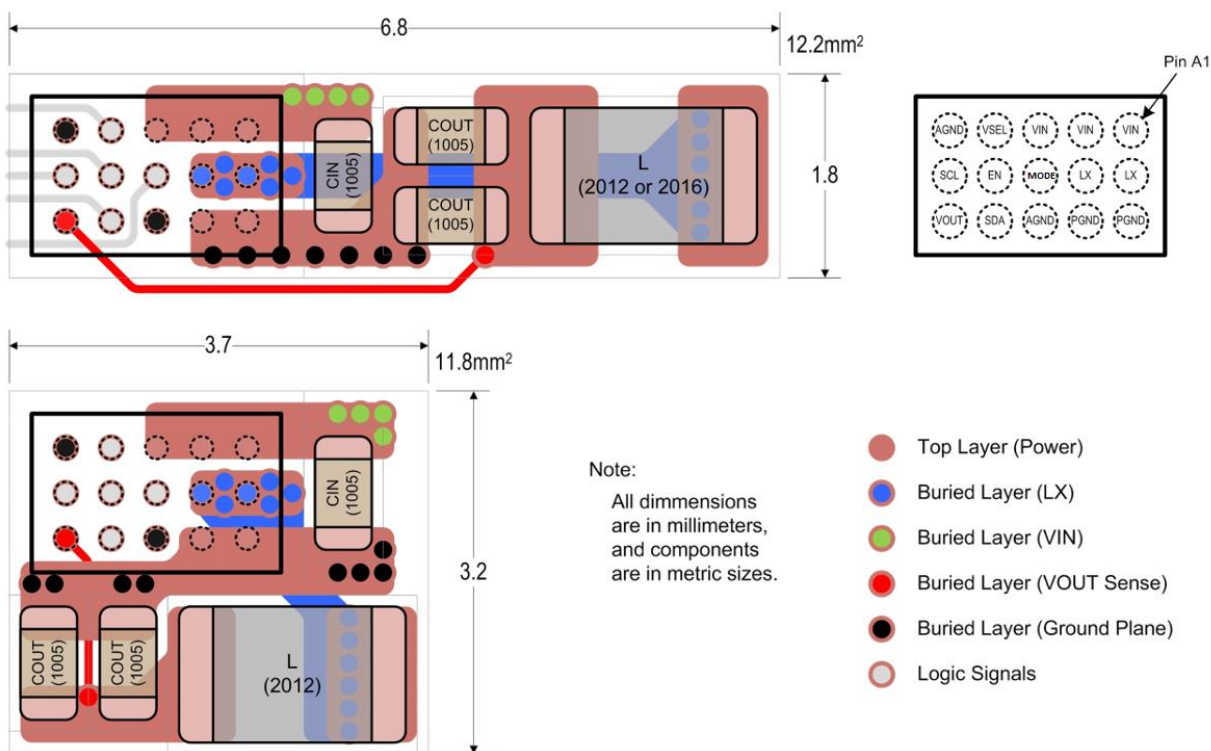
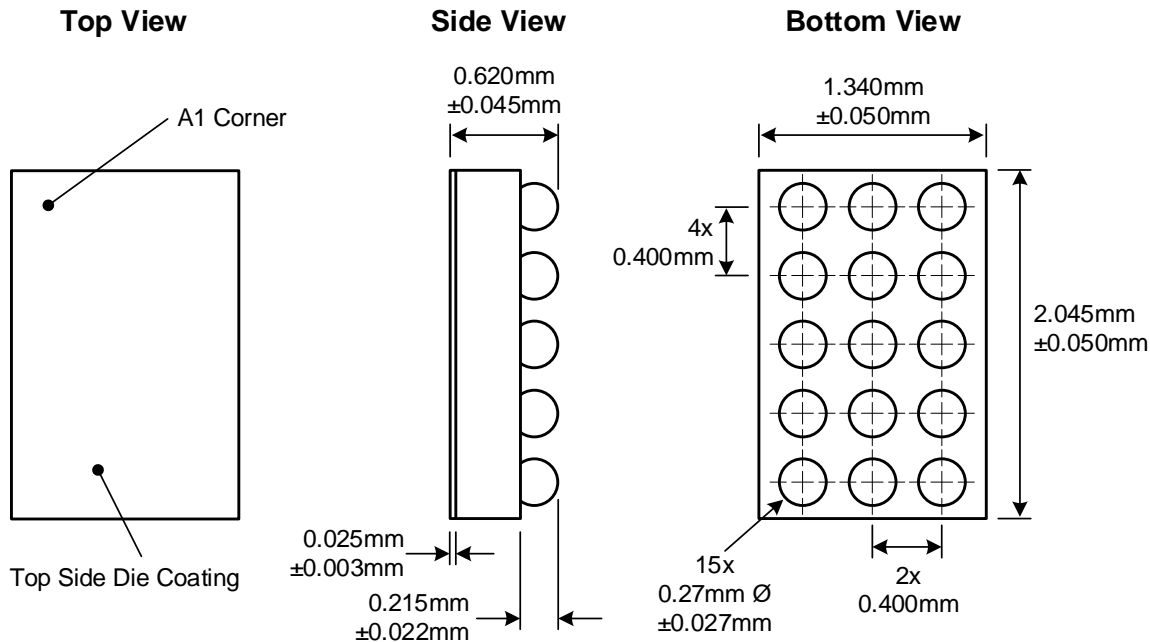

Figure 6. Two Recommended PCB Layouts

## Packaging Information

WLCSP35-15 (1.340mm x 2.045mm x 0.620mm)



## Recommended Footprint

(NSMD Pad Type)

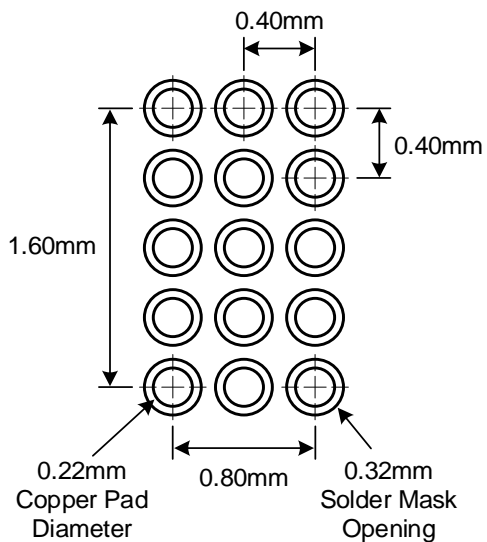

Kinetic Technologies cannot assume responsibility for use of any circuitry other than circuitry entirely embodied in a Kinetic Technologies product. No intellectual property or circuit patent licenses are implied. Kinetic Technologies reserves the right to change the circuitry and specifications without notice at any time.